



FS-i6
Digital Proportional Radio Control System

INSTRUCTION MANUAL



2.4GHz
AFHDS 2A

Digital Proportional Radio Control System

Copyright ©2015-2016

Flysky RC model technology co., ltd

WARNING:
This product is only for 15 years old or above

CE 0678
FCC ID:N4ZFLYSKYI6



Thank you for purchasing our product, an ideal radio system for beginners or experienced users alike.

Read this manual carefully before operation in order to ensure your safety, and the safety of others or the safe operation of your system.

If you encounter any problem during use, refer to this manual first. If the problem persists, contact your local dealer or visit our service and support website for help:

<http://www.flysky-cn.com>

Table of Contents

1. Safety	4
1.1 Safety symbols	4
1.2 Safety Guide.....	4
2. Introduction	6
2.1 System features.....	6
2.2 Transmitter overview	7
2.2.1 Transmitter antenna	8
2.2.2 Battery indicator.....	8
2.2.3 Trims.....	8
2.3 Receiver overview	8
2.3.1 Receiver antenna.....	8
2.3.2 Connectors	8
3. Getting Started	9
3.1 Transmitter battery installation.....	9
3.2 Connecting the receiver and servos	9
4. Operation Instructions	10
4.1 Power on.....	10
4.2 Binding.....	10
4.3 Pre-use check.....	10
4.4 Power off.....	10
5. Function description	11
5.1 Flight control	11
5.2 Reverse.....	12
5.3 End points.....	12
5.4 Display.....	13
5.5 Aux. channels.....	13
5.6 Subtrim	13
5.7 Dual rate/exp	14
5.8 Throttle curve	14
5.9 Mix.....	15
5.10 Elevon	15
5.11 V tail	15
5.12 Switches assign.....	16
5.13 Throttle hold.....	16
6. Helicopter function	17
6.1 Pitch curve	17
6.2 Swash AFR.....	17
6.3 Gyroscope.....	17
7. System	18
7.1 Model select.....	18
7.2 Model name.....	18
7.3 Type select.....	18
7.4 Model copy	18

7.5 Model reset	18
7.6 Trainer mode	18
7.7 Student mode.....	19
7.8 Sticks mode	19
7.9 LCD brightness	19
7.10 Firmware ver.	19
7.11 Frimware update	19
7.12 Factory reset.....	19
8. RX setup.....	20
8.1 RF standard	20
8.2 PPM output.....	20
8.3 RX battery	20
8.4 Failsafe	20
8.5 Sensor list.....	21
8.6 Choose sensors.....	21
8.7 Speed-distance	21
8.8 i-BUS setup.....	21
8.9 Servos ferq.....	22
9.Package contents.....	23
10. Product specifications.....	24
10.1 Transmitter specification (FS-i6)	24
10.2 Receiver specification(FS-iA6)	24
Appendix 1 FCC Statement	2

1. Safety

1.1 Safety Symbols

Pay close attention to the following symbols and their meanings. Failure to follow these warnings could cause damage, injury or death.

 **Danger** • **Not following these instructions may lead to serious injuries or death.**

 **Warning** • **Not following these instructions may lead to major injuries.**

 **Attention** • **Not following these instructions may lead to minor injuries.**

1.2 Safety Guide



Prohibited



Mandatory



- **Do not fly at night or in bad weather like rain or thunderstorm. It can cause erratic operation or loss of control.**
- **Do not use the product when the visibility is limited.**
- **Do not use the product on rainy or snowy days. Should any type of moisture (water or snow) enter any component of the system, erratic operation and loss of control may occur.**
- **Interference could cause loss of control. To ensure the safety of you and others, do not operate in the following places:**
 - Near any site where other radio control activity may occur
 - Near high voltage power lines or communication broadcasting antennas
 - Near people or roads
 - On waterways where passenger boats are present
- **Do not store your R/C system in the following places:**
 - In extremely hot or cold environments
 - Where the system will be exposed to sunlight
 - Where the humidity is high
 - Near sources of steam or condensation
- **Do not use this product when you are tired, uncomfortable, or under the influence of alcohol or drugs. It may cause serious injury to yourself as well as others.**
- **Do not leave within reach of small children or animals.**
- **Never grip the transmitter antenna when operating a model. It significantly degrades the RF signal quality and strength and may cause loss of control.**



- **Misuse of this product can lead to serious injuries or death. To ensure the safety of you and your equipment, read this manual and follow the instructions.**
- **Make sure the product is properly installed in your model. Failure to do so may result in serious injury.**
- **Make sure to disconnect the receiver battery before turning off the transmitter. Failure to do so may lead to unintended operation and cause an accident.**
- **The 2.4GHz radio band is completely different from the previously used lower frequency bands. Always keep your model in sight as a large object can block the RF signal and lead to loss of control.**
- **Note that 2.4GHz systems may affect nearby planes or cars after you turn on the transmitter.**

2. Introduction

The FS-i6 transmitter and FS-iA6 receiver constitute a 6-channel 2.4GHz AFHDS 2A digital proportional computerized R/C system. It is compatible with fixed-wing, glider and helicopters.

2.1 System Features

The AFHDS 2A (Automatic Frequency Hopping Digital System Second Generation) developed and patented by FLYSKY is specially developed for all radio control models. Offering superior protection against interference while maintaining lower power consumption and high reliable receiver sensitivity, FLYSKY's AFHDS technology is considered to be one of the leaders in the RC market today.



Bidirectional Communication

Capable of sending and receiving data, each transmitter is capable of receiving data from temperature, altitude and many other types of sensors, servo calibration and i-BUS Support.



Multi-channel Hopping Frequency

This system's bandwidth ranges from 2.4055GHz to 2.475GHz. This band is divided in 140 channels. Each transmitter hops between 16 channels (32 for Japanese and Korean versions) in order to reduce interference from other transmitters.



Omni-directional Gain Antenna

The high efficiency Omni-directional high gain antenna cuts down on interference, while using less power and maintaining a strong reliable connection.



Unique ID Recognition System

Each transmitter and receiver has its own unique ID. Once the transmitter and receiver have been paired, they will only communicate with each other, preventing other systems accidentally connecting to or interfering with the system's operation.



Low Power Consumption

The system is built using highly sensitive low power consumption components, maintaining high receiver sensitivity, while consuming as little as one tenth the power of a standard FM system, dramatically extending battery life.

2.2 Transmitter overview

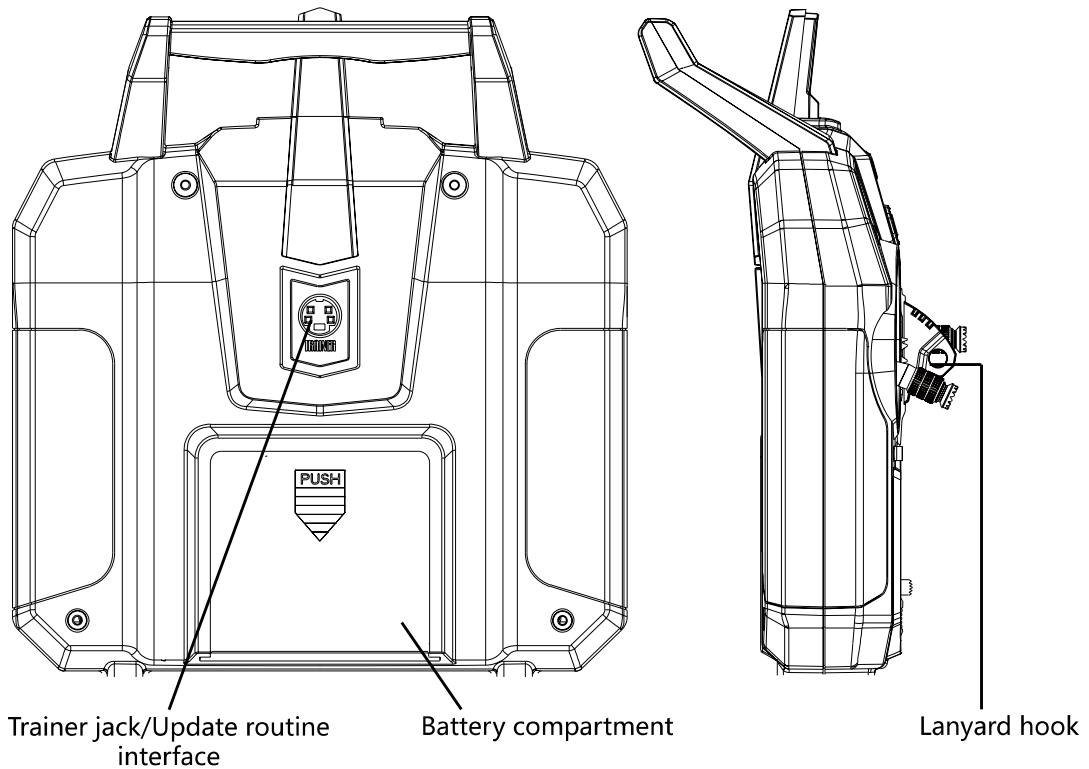
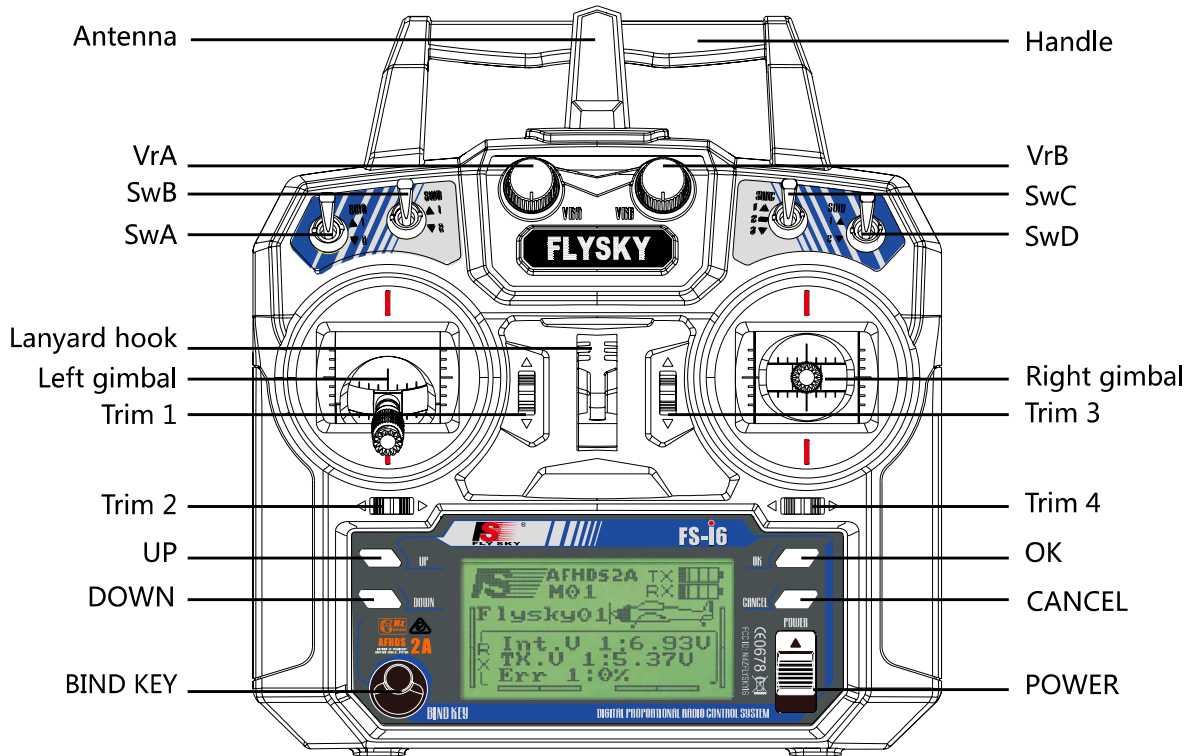

2.2.1 Transmitter antenna

- Warning** • For best signal quality, make sure that the antenna is at about a 90 degree angle to the model. Do not point the antenna directly at the receiver.
- Danger** • Never grip the transmitter antenna during operation. It significantly degrades the RF signal quality and strength and may cause loss of control.

2.2.2 Battery indicator

The status indicator is used to indicate the power and status of the transmitter and receiver. If a receiver is not connected or bound to the transmitter no battery status will be displayed for the receiver.



2.2.3 Trims

There are 4 trims affecting stick functionality, one for ailerons (Channel 1), elevator (Channel 2), throttle (Channel 3) and rudder (Channel 4). Each time a trim is toggled, the trim will move one step. It is possible to make quicker trim adjustments by holding the trim in the desired direction. When the trim position reaches the middle, the transmitter beeps in a higher tone.

2.3 Receiver overview



2.3. Receiver antenna

- Attention** • For best signal quality, ensure that the receiver is mounted away from motors or metal parts.

2.3.2 Connectors

The connectors are used to connect the parts of model and the receiver.

CH1 to CH6: used to connect the servos, power or other parts.

B/VCC: used to connect the bind cable for binding, and the power cable during normal operation.

3. Getting Started

Before flight check the following guidelines to set up your system.

3.1 Transmitter Battery Installation

-  **Danger** • Only use the battery specified by the manufacturer

-  **Danger** • Do not attempt to open, dismantle or repair the battery.

-  **Danger** • Do not crush, puncture or allow the contacts to touch conductive materials.

-  **Danger** • Do not expose the battery to extreme temperatures or liquid.

-  **Danger** • Do not drop or expose to excessive vibration.

-  **Danger** • Store in a cool, dry environment.

-  **Danger** • If the battery is damaged cease use immediately.

Follow the steps below to install the battery:

1. Remove the battery compartment cover.
2. Insert 4 fully charged AA batteries, making sure that each battery is orientated correctly.
3. Replace battery compartment cover.

3.2 Receiver and servos

Follow the steps below to connect servos to the receiver:

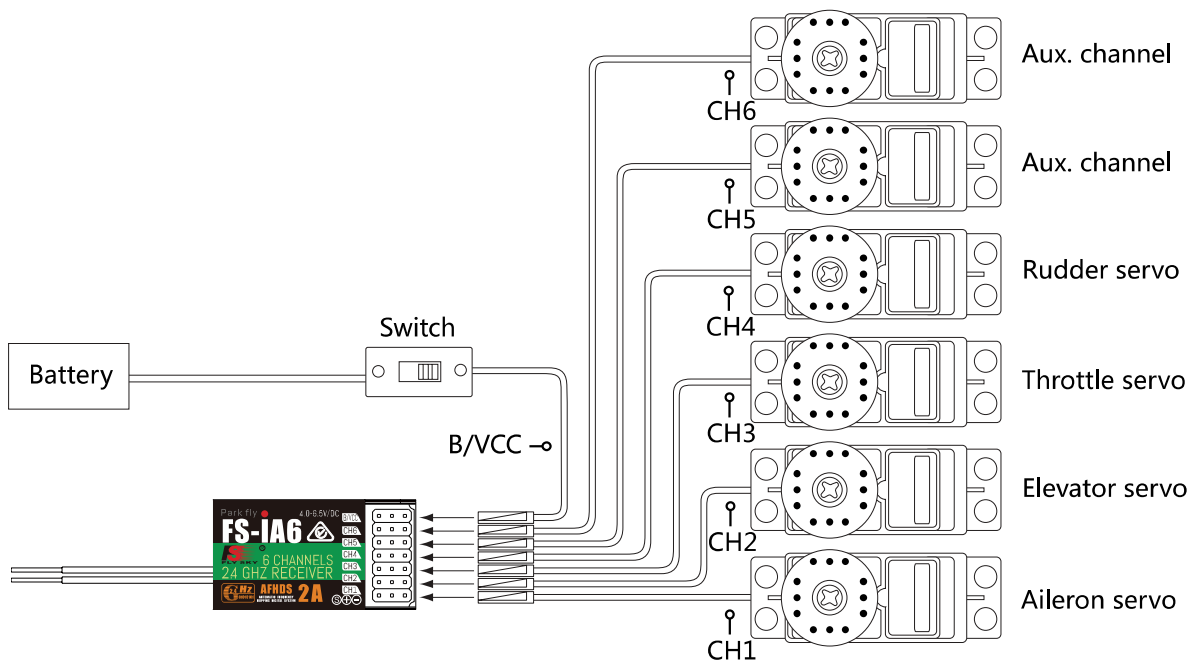

4. operation instructions

After setting up, follow the instructions below to operate the system.

4.1 Power on

Follow the steps below to turn on the system:

1. Check the system and make sure that:
 - The batteries are fully charged and installed properly.
 - The receiver is off and correctly installed.
2. Hold the "POWER" switch until screen lights up.
3. Connect the receiver power supply to the **B/VCC** port on the receiver.



Note: The system is now powered on. Operate with caution, or serious injury could result.

4.2 Binding

The transmitter and receiver have been pre-bound before delivery. If you are using another transmitter or receiver, follow the steps below to bind the transmitter and receiver:

1. Connect the supplied bind cable to the B/VCC port on the receiver.
2. Insert power into any other port.
3. Hold the "BIND KEY" while powering on the transmitter to enter bind mode.
4. Remove the power and bind cable from the receiver. Then connect the power cable to the B/VCC port.
5. Check the servos' operation. If anything does not work as expected, restart this procedure from the beginning.

4.3 Pre-use check

Before operation, perform the following steps to check the system:

1. Check to make sure that all servos and motors are working as expected.
2. Check operating distance: one operator holds the transmitter, and another one moves the model away from the transmitter. Check the model and mark the distance from where the model starts to lose control.



Danger • Stop operation if any abnormal activity is observed.



Danger • Make sure the model does not go out of range.



Caution • Sources of interference may affect signal quality.

4.4 Power off

Follow the steps below to turn off the system:

1. Disconnect the receiver power.
2. Hold the transmitter's power buttons to turn off the transmitter.



Caution • Make sure to disconnect the receiver power before turning off the transmitter. Failure to do so may lead to damage or serious injury.

5. Function description

5.1 Flight Controls (Mode 2)

The sticks are used for controlling the aircraft, each stick has 2 functions. The right stick controls pitch and roll, the left stick controls throttle and yaw.

Pitch (Right Stick Up/Down)

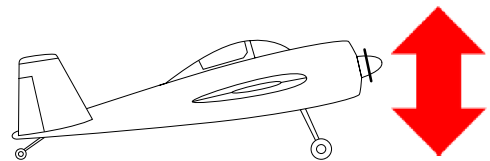
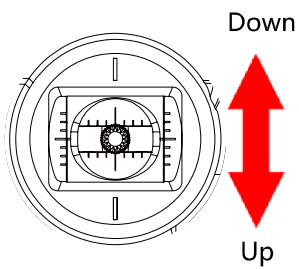
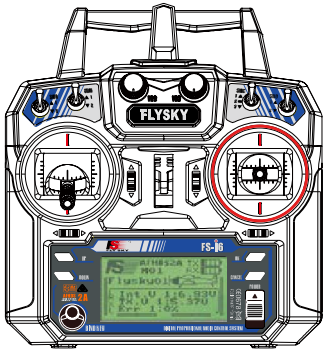

Roll (Right Stick Left/Right)

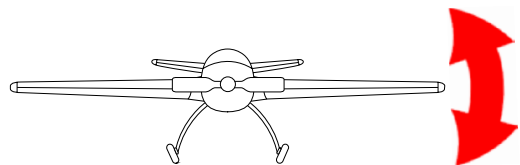
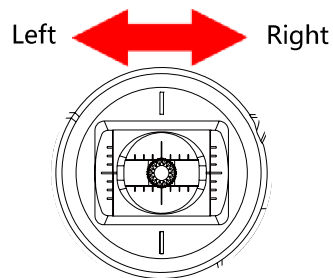
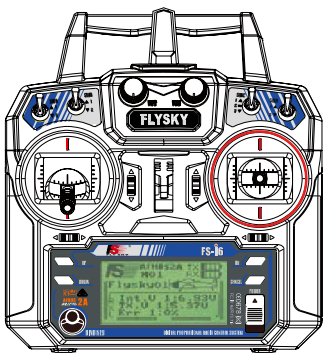

Yaw (Left Stick Left/Right)

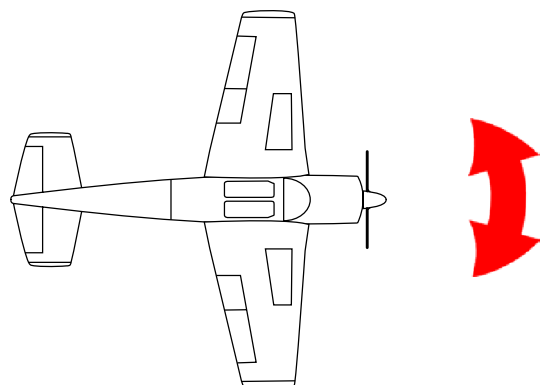
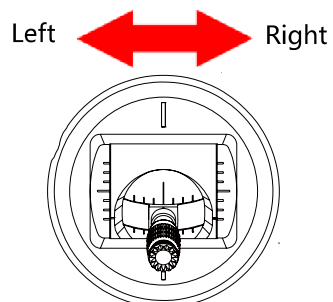
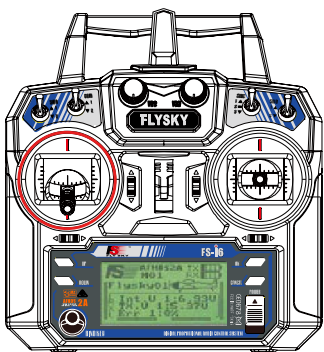

Throttle (Left Stick Up/Down)

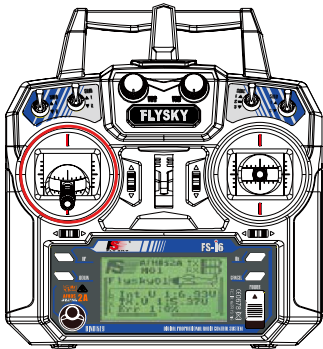

Throttle Up

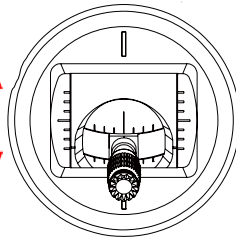

Throttle Down

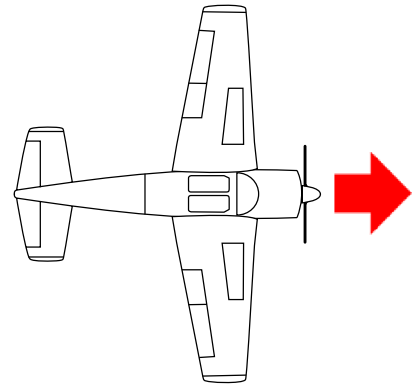

5.2 Reverse

The reverse function changes a channels direction of movement in relation to its input. For example, if a servo has to be mounted upside down due to space restrictions within a model, this function can be used to correct its movement so that it matches up with the user controls.

Setup:

1. To change between normal and reverse press the "OK" key until the desired channel is selected, then use the "UP" and "DOWN" keys to change setting.

Nor = Normal, Rev = Reverse.

2. Hold the "CANCEL" key to save and return to the previous menu.
3. To return to default settings press and hold the "OK" key for 3 seconds. Press and hold the "CANCEL" key to save.

Reverse

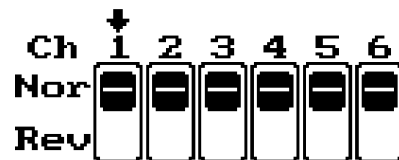

5.3 End points

The end points function changes the range of movement available to a channel. This can be used to prevent damage to a model when a servo moves too far, potentially leading to damage to pushrods etc. The left box is the low end point, the right box is the high end point, marked below as low being red and blue being high.

To change an endpoint:

1. Press the "OK" to change channels.
2. Move the channel using its stick or knob to select the low or high side.
3. Use the "UP" and "DOWN" keys to increase or decrease the value.
4. Hold the "CANCEL" key to save and return to the previous menu.

End points

Ch1	→	<input type="checkbox"/>	<input type="checkbox"/>
Ch2		<input type="checkbox"/>	<input type="checkbox"/>
Ch3		<input type="checkbox"/>	<input type="checkbox"/>
Ch4		<input type="checkbox"/>	<input type="checkbox"/>
Ch5		<input type="checkbox"/>	<input type="checkbox"/>
Ch6		<input type="checkbox"/>	<input type="checkbox"/>

5.4 Display

This function displays the model's channel output in real time.

Setup:

1. Hold the "OK" key to enable channel scrub mode. In this mode the channels will sweep through their entire range of motion.
2. Press "CANCEL" key to exit.



Warning

- **Make sure the model engine is powered off while the test function is activated. If powered on, it will rev up and cause unexpected results.**



Danger

- **Make sure the model does not go out of range.**

Display

Ch1			
Ch2			
Ch3			
Ch4			
Ch5			
Ch6			

5.5 Aux. channels

The auxiliary channels function can be used to assign switches to extra channels to control additional part of a model such as landing gear or lights.

In some model types, such as the variable pitch helicopter model, the 6th channel will already be in use.

In model types that use a gyro the fifth channel will already be in use.

To assign a switch or knob to an Aux channel:

1. Press the "OK" to change channels.
2. Use the "UP" and "DOWN" keys to select a source (Switch or Knob/None).
3. Hold the "CANCEL" key to save and return to the previous menu.

Aux. channels

Channel 5
Source UrA

Channel 6
Source UrB

5.6 Subtrim

Subtrim changes the center point of the channel. For example, if a model's rudder is slightly out of alignment, the sub trim could be used to fix this.

To set the subtrim:

1. Press the "OK" to change channels.
2. Use the "UP" and "DOWN" keys to change the sub trim position.
3. Hold the "CANCEL" key to save and return to the previous menu.
4. To return to default settings press and hold the "OK" key for 3 seconds. until the channel returns to the center. Press and hold the "CANCEL" key to save.

Subtrim

Ch1		
Ch2		
Ch3		
Ch4		
Ch5		
Ch6		

5.7 Dual rate/exp.

The dual rate/exp. function only applies to channels 1,2,4.

Dual Rate: Dual Rate reduces or increases the difference between the highest and lowest possible value, for example if applied to the rudder, (set to a throw of 10cm) before changing the settings, when you move your stick to 1/2 you would get 5cm rudder movement, if you move the stick 1/4 of the way, the rudder will move 2.5cm, so at 100% there is a direct, linear relationship of stick movement and surface movement.

If a setting of 50% is entered then moving the stick all the way in one direction will only give 1/2 of the surface movement and 1/2 stick movement will only produce 1/4 surface movement, this has the effect of reducing how responsive the rudder is when the stick is moved, effectively reducing the range of movement available to the servo. This function is usually assigned to a condition so that it can be turned on and off during flight.

Exp. (Exponential): Exponential changes the relationship between stick movement and surface movement by creating a curve, when in use the stick movement and surface movement are no longer linear so the stick has a different response in different at different positions. For example this is useful when needing less reaction during a take-off but more reaction when in the air.

Setup:

1. Press the "OK" to change between settings.
2. Use the "UP" and "DOWN" keys to change the channel/rate/exp depending on the selected setting.
3. Hold the "CANCEL" key to save and return to the previous menu.
4. To return a setting to default, press and hold the "OK" key for 3 seconds. Press and hold the "CANCEL" key to save.

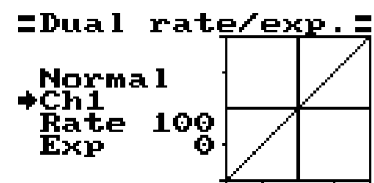

5.8 Throttle curve

This function enables the user to adjust the ratio between stick and servo movement using a linear line or non-linear curves.

This is useful when wanting to change how the throttle reacts at between different stick positions, for example having a smaller throttle change when the stick is between 0-30%, then a larger throttle change between 30% and 100%. If your models throttle is not linear, it is also possible to use this function to create a more linear movement.

This function uses 5 points to change the throttle curve, L being the low and H being the high.

Setup:

1. Press the "OK" to change between points.
2. Use the "UP" and "DOWN" keys to change point position.
3. Hold the "CANCEL" key to save and return to the previous menu.
4. To return a setting to default, press and hold the "OK" key for 3 seconds. Press and hold the "CANCEL" key to save.

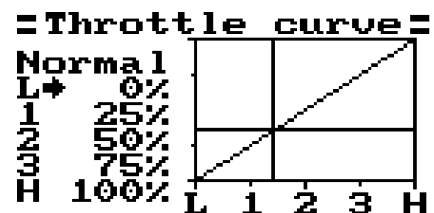

5.9 Mix

This function is used to create a mix between channels. For example if at low throttle some automated flap movement was desired then it is possible to create a mix to do this. This system can have up to 3 different mixes.

Setup:

[**Master**]: This channel will control the slave.

[**Slave**]: This channel is controlled by the master.

[**Offset**]: Changes the centre point for the mix

[**Neg. mix**]: Defines the master's effect on the slave channel while in the positive direction.

[**Pos. mix**]: Defines the master's effect on the slave channel while in the negative direction.

1. Use the "UP" and "DOWN" keys to select a mix.
2. Use the "OK" key to change between settings.
3. Select a master channel, this channel will control the slave channel.
4. Select a slave channel to be controlled by the master.(CH1-CH6,VrA and VrB)
5. Set the positive and negative mix, this setting controls how much the slave channel will move in relation to the masters movement, if set to 50% the slave will move half the amount of the master.
6. Set the offset, the offset changes the centre of the slave channel in relation to the master.
7. Hold the "CANCEL" key to save and return to the previous menu.
8. To return a setting to default, press and hold the "OK" key for 3 seconds. Press and hold the "CANCEL" key to save.

```

===== Mix =====
→ Mix#1
  Mix is      Off
  Master     Ch1
  Slave      Ch2
  Pos. mix   50%
  Neg. mix   50%
  Offset     0%
  
```

5.10 Elevon

The elevon function is used for planes that combine the elerons an alerons together.

Setup:

1. Use the "UP" and "DOWN" to turn the function on and off.
2. Use the "OK" key to change between settings.
3. Use the "UP" and "DOWN" keys to change the percentage.
4. To return a setting to default, press and hold the "OK" key for 3 seconds. Press and hold the "CANCEL" key to save.

```

===== Elevon =====
→ Elevon On
  Ch1 50%
  Ch2 50%

  Ch1 <= Ch2+Ch1
  Ch2 <= Ch2-Ch1
  
```

5.11 V tail

Used for planes that use a v tail configuration.

Setup:

1. Use the "UP" and "DOWN" to turn the function on and off.
2. Use the "OK" key to change between settings.
3. Use the "UP" and "DOWN" keys to change the percentage.
4. To return a setting to default, press and hold the "OK" key for 3 seconds. Press and hold the "CANCEL" key to save.

```

===== U tail =====
→ U tail On
  Ch2 50%
  Ch4 50%

  Ch2 <= Ch2-Ch4
  Ch4 <= Ch2+Ch4
  
```

5.12 Switches assign

This function enables you to assign switches to Fly mode, Idel mode, and throttle hold.

Setup:

1. Use the "OK" key to change between settings.
2. Use the "UP" and "DOWN" keys to change switch assignment.
3. To return a setting to default, press and hold the "OK" key for 3 seconds. Press and hold the "CANCEL" key to save.

:Switches assign:

```

*Fly mode   SwA
  Normal
Idle mode   SwB
  Normal
Thro. hold SwD
  Off
    
```

5.13 Throttle hold

This function is used with gas powered models in order to stop stalls when not in use.

Setup:

1. Use the "OK" key to change between settings.
2. Use the "UP" and "DOWN" keys to turn the function on or off and increase and decrease the hold percentage.
3. To return a setting to default, press and hold the "OK" key for 3 seconds. Press and hold the "CANCEL" key to save.

=Throttle hold=

```

*Hold   Off
Value  50%

Not engaged
    
```



Note

- This function must be assigned to a switch in the Switches assign function.

6. Helicopter Functions

6.1 Pitch Curve

This function is used for creating a curve that adjusts pitch control.

Setup:

This function uses points for adjustment across the sticks range of movement.

The horizontal axis represents the input.

The vertical axis represents the output.

1. Press the "OK" button to change between points.
2. Use the "UP" and "Down" arrow keys to change a points value.
3. Press and hold the "OK" button for 3 seconds to reset to factory default or hold the "CANCEL key to save and exit.

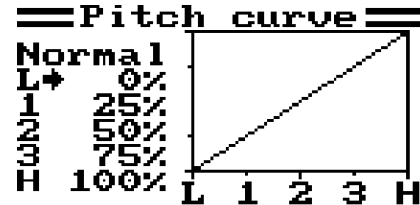

6.2 Swash AFR

The **[Swash AFR]** function sets the relative movement between each servo controlling movement of the swash plate controlling aileron, elevator and pitch.

Setup:

The function can be adjusted from -100 to 100 percent. The system default is set at 50 percent.

1. Press the "Ok" key to change between settings.
2. Use the "UP" and "DOWN" keys to change the settings value.
3. Press and hold the "OK" button for 3 seconds to reset to factory default or hold the "CANCEL key to save and exit.

6.3 Gyroscope

This function is used to adjust the gyro sensitivity. If the sensitivity is too high, the helicopter will oscillate with the tail moving from side to side; and if the sensitivity is too low, the helicopter will be sluggish and unresponsive. When in use this function uses channel 5.

There are 2 settings within this function, on/off and percentage.

Setup:

1. Use the "Up" and "Down" keys to turn the gyro function on or off. Then press the "OK" key to change options.
2. Use the "UP" and "DOWN" keys to change the value percentage.
3. Press and hold the "OK" button for 3 seconds to reset to factory default or hold the "CANCEL key to save and exit.

7. System

7.1 Model select

Use this function to select stored models, use the "UP" and "DOWN" keys to choose a model and press and hold the "CANCEL" key to save and exit. The system can store up to 20 models.

7.2 Model name

This function renames the currently selected model.

To change the name:

Use the "Up" and "Down" keys to select a letter or number, then press the ok key to confirm.

To save press and hold the "CANCEL" key.

7.3 Type select

This function changes the type of the currently selected model, including airplane and helicopter with different types of swash plates.

To change the model type press the "UP" and "DOWN" keys to select the model type, then press and hold the ok key to save and exit.

Swash Plate Type	Functions
Swash 140°	Pitch Curve,Swash AFR,Gyroscope
Swash 120°	Pitch Curve,Swash AFR,Gyroscope
Swash 90°	Pitch Curve,Swash AFR,Gyroscope
Variable pitch	Pitch Curve,Gyroscope
Fixed pitch	Gyroscope

7.4 Model copy

This function copies the one model to another model slot.

To copy a model:

1. Use the "UP" and "DOWN" keys to select the model you want to copy.
2. Use the "OK" key to and use the "UP" and "DOWN" keys to select the slot to copy the model to0.
3. Press and hold the "OK" key to confirm, the system will display a prompt asking "Are you sure", use the "UP" or "DOWN" key to select yes and press "OK" again to confirm.

7.5 Model reset

This function resets the current model to the default settings.

Setup:

1. Use the "UP" and "DOWN" keys to select a model. Press the "OK" key to confirm,.
2. The system will display a prompt asking "Are you sure", use the "UP" or "DOWN" key to select Yes and press "OK" key again to confirm.

7.6 Trainer mode

Trainer mode is used to take control of a slave system when a switch is in the off position. This function will only work when two systems are linked via the trainer lead.

Setup (This function must be assigned to a switch and will only be inactive when the switch is on):

1. Use the "UP" and "DOWN" keys turn the function on and off.
2. Use the "OK" key to and use the "UP" and "DOWN" keys to select a switch.
3. Press and hold the "CANCEL" key to save and exit.

7.7 Student mode

Student mode is used when another system is connected as a master (Trainer), when this mode is active all settings will be bypassed and the system will only function through the master.

Setup:

1. To enable the function press "OK" then select Yes, The system will return to the previous menu.
2. To exit student mode repeat this process.

7.8 Sticks mode

There are 4 available stick modes, each stick mode changes the stick functions. For example when using stick mode 2 the left stick controls throttle on the vertical axis and rudder in the horizontal axis, however in stick mode 3, the vertical axis controls elevator and the horizontal axis controls aileron. These modes are largely down to personal preference.

Setup:

To change stick modes use the "UP" and "DOWN" keys to select a stick mode, then press and hold the "CANCEL" key to save and exit.

- When switching between modes 1/3 and 2/4 it is necessary to reverse the gimbals positions to ensure that throttle is on the correct side.

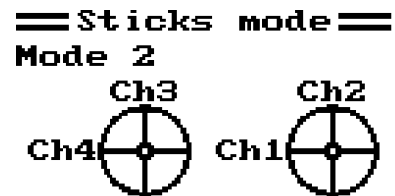

7.9 LCD brightness

To change the LCD brightness use the "UP" and "DOWN" keys. Press and hold "CANCEL" to save and exit.

7.10 Firmware ver.

This function displays the current firmware version.

7.11 Firmware update

This function updates the firmware using a USB to PS/2 connection lead.

Setup:

1. First download the update from our website, <http://www.flysky-cn.com>.
2. Connect the system to the computer via the supplied cable and press "OK" while in this function.
3. Wait for windows to recognise the system.
4. Then open the update on the computer and press "Start Upgrade".
5. Once the update is finished cycle the system power.

7.12 Factory reset

This function resets the entire system back to its factory settings. To reset press ok, then use the up and down keys to select yes and press ok again.

8 RX Setup

8.1 RF standard

This menu allows you to change the communication protocol for the transmitter. The available protocols are:

RF Protocol	Receiver
AFHDS	R9B,R6B,R6C,GR3E,GR3F
AFHDS 2A	A3, A6,X6, iA4B, iA6, iA6B, iA10, iA10B

To Switching Between AFHDS 2A and AFHDS:

1. First navigate to the system menu by pressing and holding the "OK" key until the main menu opens, select "System Setup" by pressing the "OK" key again.
2. Use the "DOWN" key to navigate to "RX setup" and press the "OK" key again to enter, then press the "OK" key one more time to select RF Standard.
 - Press the "UP" or "DOWN" button to select the latest protocol,AFHDS 2A 2-Way (The most advanced and stable protocol). After restarting the system the new protocol will become the default.
3. Use the "UP" and "DOWN" keys to select a mode then press and hold the "CANCEL" key to save and exit.

8.2 PPM output

PPM is capable of transferring all channels through one physical output. When [RX PPM output] is checked, the receiver outputs PPM on CH1 output and the other outputs are disabled.

- When [PWM] is selected the receiver will output channels 1-6 via channel 1-6.
- When [PPM] is selected the receiver will output a standard PPM signal via the PPM interface.

To turn the function on press the "UP" or "DOWN" keys to turn the function on then press and hold the "CANCEL" key to save and exit.

8.3 RX battery

This function is used to change the battery monitor settings. This function can be switch to an external or internal sensor.

There are 4 settings:

[External sensor/ Internal Sensor]The system has its own voltage sensor however it is possible to change to an external sensor.

[Low] Sets the low battery voltage, see your batteries user manual to set this setting.

[Alarm]Sets the voltage level at which the system will alert the user if the battery gets too low.

[High]Sets the voltage for the battery if it is full.

- These settings affect how the system shows battery levels, if the high and low are incorrect the systems battery display will not be reliable.

8.4 Failsafe

This function is used to protect the models and users if the receiver loses signal and therefore is no longer controllable.

All channels are listed in the failsafe menu. **[Off]** means that in case of a loss of signal, the corresponding servo will keep its last received position. If it displays a percentage, the servo will instead move to the selected position.

Setup :

1. Use the "UP" and "DOWN" to choose a channel and press "OK" to enter its failsafe settings.
2. Use the "UP" and "DOWN" to turn the failsafe on or off.
3. Move the channels control surface to the desired position and hold the "CANCEL" key to confirm and exit.
4. Press and hold the "CANCEL" key again to save all changes in this function and return to the RX setup menu.

```

=====Failsafe=====
Channel 1 OFF
Channel 2 OFF
+Channel 3 -100%
Channel 4 OFF
Channel 5 OFF
Channel 6 OFF
All channels
  
```

8.5 Sensors list

This function is used to display information from the current active sensors.

[Type]:The type of sensor is displayed on the left hand side under **[Type]** ;

The first sensor in the list is the TX internal voltage and error rate. The second sensor is the first external sensor is the receivers voltage sensor, this continues up to 15 sensors, if connected.

[ID]:The numerical ID of each sensor is in the middle under **[ID]**,

[Value]:the sensor' s output is on the right under **[Value]**.

At the bottom of the list this menu has an error rate display, which is a good indicator of signal quality.

8.6 Choose sensors

This function changes which sensors will be displayed on the home screen. The home screen can display up to 3 sensors.

To add a sensor to the home screen:

1. Use the "OK" key to change sensor slot
2. Use the up and down keys to select a sensor.
3. Press and hold the "CANCEL" key to save and exit.

8.7 Speed-distance

This function is used to detect the speed and distance traveled by the model.

[Speed sensor] Used to select the speed sensor if connected.

[Rotation length] If the sensor is mounted on a rotating part the distance from the centre point to the sensor must be input in order to calculate the correct speed.

[Reset Odometer 1] Resets odometer 1. Odometer 1 records total distance traveled from all sessions until reset.

[Reset Odometer 2] Resets odometer 2. Odometer 2 records the distance traveled in the current session.

8.8 i-BUS setup

This function is used to set up the i-BUS module. The i-BUS module can be used to add servos to your model tha may be too far away from the receiver.



Setup:

1. Use the "UP" and "DOWN" keys to choose a channel and press "OK".
2. Press the button on the i-bus module that corresponds to the desired output.
3. After setting up the desired channels press and hold the "CANCEL" key to save and exit.

8.9 Servos freq

This function sets the frequency that the receiver outputs to the servos. Check your servos usermanual to find the correct setting.

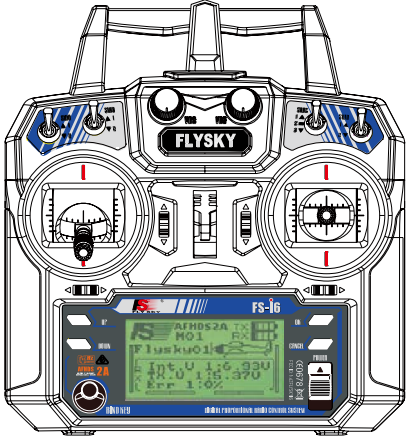
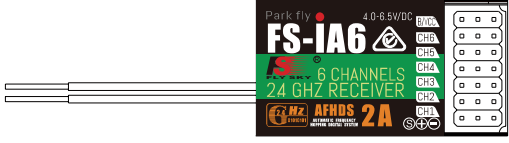
9. Package contents

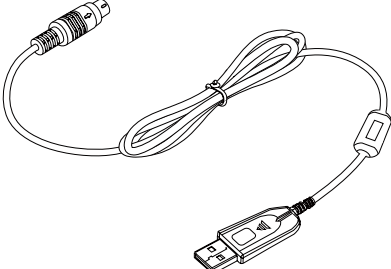
<p>2.4GHz transmitter FS-i6</p>	
<p>2.4GHz receiver FS-iA6</p>	
<p>User manual (CD)</p>	
<p>USB cable</p>	

10 Product specifications

10.1 Transmitter specification(FS-i6)

Channels	6
Model type	Fixed-wing/Glider/Helicopter
RF range	2.4055-2.475GHz
RF power	< 20dBm
RF channel	140
Bandwidth	500KHz
2.4GHz system	AFHDS 2A/AFHDS
Modulation type	GFSK
Stick resolution	4096
low voltage alarm	< 4.2V
DSC port	PS/2 PPM
Chargeable	None
Antenna length	26mm*2
Weight	392g
Power input	6V DC 1.5AA*4
Display	Transflective STN positive screen with backlight,128*64 picels,VA73*39mm
Size	174mm*89mm*190mm
On-line update	Yes
Color	Black
Certificate	CE0678 , FCC ID:N4ZFLYSKYI6

10.2 Receiver specification (FS-iA6)

Channels	6
Model type	Fixed-wing/Glider/Helicopter
Rf range	2.4055-2.475GHz
RF channel	140
RX sensitivity	-105dBm
Bandwidth	500KHz
2.4GHz system	AFHDS 2A
Modulation type	GFSK
Power input	4.0~6.5V DC
Antenna length	26mm*2
Weight	7g
Size	40.4mm×21.1mm×15mm
i-BUS port	None
Data acquisition port	None
Color	Black
Certificate	CE0678 , FCC ID:N4ZFLYSKYIA6

Appendix 1 FCC Statement

This equipment has been tested and found to comply with the limits for a Class B digital device pursuant to part 15 of the FCC rules. These limits are designed to provide reasonable protection against harmful interference in a residential installation. This equipment generates, uses and can radiate radio frequency energy and, if not installed and used in accordance with the instructions, may cause harmful interference to radio communications. However, there is no guarantee that interference will not occur in a particular installation. If this equipment does cause harmful interference to radio or television reception, which can be determined by turning the equipment off and on, the user is encouraged to try to correct the interference by one or more of the following measures:

- Reorient or relocate the receiving antenna.
- Increase the separation between the equipment and receiver.
- Connect the equipment into an outlet on a circuit different from that to which the receiver is connected.
- Consult the dealer or an experienced radio/TV technician for help.

To assure continued compliance, any changes or modifications not expressly approved by the party responsible for compliance could void the user's authority to operate this equipment. (Example use only shielded interface cables when connecting to computer or peripheral devices).

This equipment complies with Part 15 of the FCC Rules. Operation is subject to the following two conditions:

- (1) This device may not cause harmful interference, and
- (2) This device must accept any interference received, including interference that may cause undesired operation.

Caution!

The manufacturer is not responsible for any radio or TV interference caused by unauthorized modifications to this equipment. Such modifications could void the user authority to operate the equipment.



Digital Proportional Radio Control System

CE 0678 FCC ID:N4ZFLYSKYI6

<http://www.flysky-cn.com>

Copyright ©2015-2016 Flysky RC model technology co., ltd

Edition: 2016-08-19